

G502

Hohlschraube

mit Schlitzschraube und Kontermutter (B)
mit Schlitzschraube und Rändelkopf (C)



Teile-Nr.	Abmessungen, Preise und Lieferzeit auf Anfrage
G502-B	
G502-C	

G510

Abluftdrossel

mit Schalldämpfer und Kontermutter aus Messing

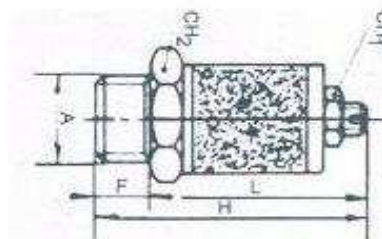

Teile-Nr.	G	F	CH1	CH2	Lmax.	Lmin.	Hmin.	Hmax.	-	Stück
G510-M5	M 5	3,5	6	8	13	18	16	21	-	8,94 €
G510-18	1/8	6,5	10	16	30	36	38	44	-	8,16 €
G510-14	1/4	9	10	16	30	36	39	45	-	9,39 €
G510-38	3/8	10	10	22	37	50	47	60	-	13,53 €
G510-12	1/2	11	10	22	37	50	48	61	-	13,98 €

Für Ihre Notizen

G515

Handschiebeventil aus Messing

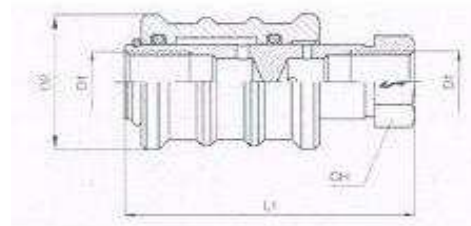

Teile-Nr.	D1	-	D2	-	L1	-	-	CH	-	Stück
G515-M5	M5	-	13	-	31	-	-	9	-	10,53 €
G515-18	1/8	-	25	-	48	-	-	14	-	9,49 €
G515-14	1/4	-	30	-	58	-	-	17	-	11,32 €
G515-38	3/8	-	35	-	68	-	-	22	-	12,98 €
G515-12	1/2	-	40	-	80	-	-	27	-	17,19 €

G520

Drosselrückschlagventil in Blockform

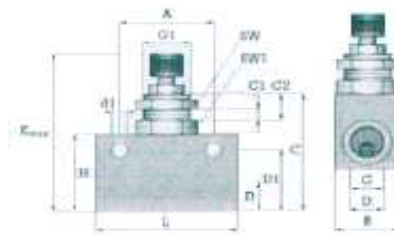

Teile-Nr.	G	-	-	-	-	-	-	-	Farbe/Material	Stück
G520-M5 AL	M5	-	-	-	-	-	-	-	Alu	11,48 €
G520-M5 s	M5	-	-	-	-	-	-	-	schw.	11,48 €
G520-18 AL	1/8	-	-	-	-	-	-	-	Alu	12,81 €
G520-18 s	1/8	-	-	-	-	-	-	-	schw.	12,81 €
G520-14 AL	1/4	-	-	-	-	-	-	-	Alu	16,64 €
G520-14 s	1/4	-	-	-	-	-	-	-	schw.	16,64 €
G520-38 AL	3/8	-	-	-	-	-	-	-	Alu	26,73 €
G520-38 s	3/8	-	-	-	-	-	-	-	schw.	26,73 €
G520-12 AL	1/2	-	-	-	-	-	-	-	Alu	31,11 €
G520-12 s	1/2	-	-	-	-	-	-	-	schw.	31,11 €

G521 Drosselventil in Blockform

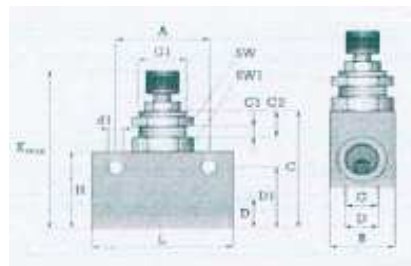

Teile-Nr.	G	-	-	-	-	-	-	-	-	Farbe/Material	Stück
G521-M5 AL	M5	-	-	-	-	-	-	-	-	Alu	11,29 €
G521-M5 s	M5	-	-	-	-	-	-	-	-	schw.	11,29 €
G521-18 AL	1/8	-	-	-	-	-	-	-	-	Alu	12,53 €
G521-18 s	1/8	-	-	-	-	-	-	-	-	schw.	12,53 €
G521-14 AL	1/4	-	-	-	-	-	-	-	-	Alu	16,41 €
G521-14 s	1/4	-	-	-	-	-	-	-	-	schw.	16,41 €
G521-38 AL	3/8	-	-	-	-	-	-	-	-	Alu	26,55 €
G521-38 s	3/8	-	-	-	-	-	-	-	-	schw.	26,55 €
G521-12 AL	1/2	-	-	-	-	-	-	-	-	Alu	30,87 €
G521-12 s	1/2	-	-	-	-	-	-	-	-	schw.	30,87 €

G522 Drosselrückschlagventil in Sechskantform

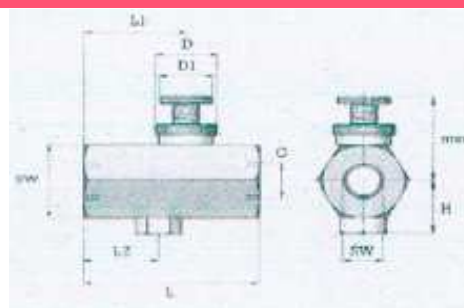

Teile-Nr.	G	-	-	-	-	-	-	-	-	Farbe/Material	Stück
G522-18 AL	1/8	-	-	-	-	-	-	-	-	Alu	12,23 €
G522-18 s	1/8	-	-	-	-	-	-	-	-	schw.	12,23 €
G522-14 AL	1/4	-	-	-	-	-	-	-	-	Alu	16,04 €
G522-14 s	1/4	-	-	-	-	-	-	-	-	schw.	16,04 €

G523 Drosselventil in Sechskantform

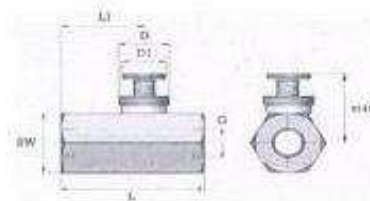

Teile-Nr.	G	-	-	-	-	-	-	-	Farbe/Material	Stück
G523-18 AL	1/8	-	-	-	-	-	-	-	Alu	12,05 €
G523-18 s	1/8	-	-	-	-	-	-	-	schw.	12,05 €
G523-14 AL	1/4	-	-	-	-	-	-	-	Alu	15,88 €
G523-14 s	1/4	-	-	-	-	-	-	-	schw.	15,88 €

G524 Rückschlagventil mit beiderseits Außengewinde aus Messing

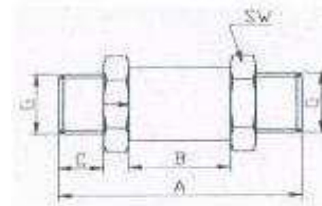

Teile-Nr.	G	A	B	C	SW	-	-	-	-	Stück
G524-14	1/4	48,5	15,5	9	17	-	-	-	-	9,46 €
G524-38	3/8	54	15	11,5	19	-	-	-	-	14,98 €
G524-12	1/2	-	-	-	24	-	-	-	-	19,56 €

G525 Rückschlagventil mit Innengewinde, Messing blank/vernickelt

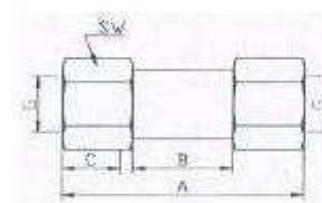

Teile-Nr.	G	A	B	C	SW	-	-	-	-	Stück
G525-14	1/4	48,5	20,5	8	17	-	-	-	-	7,10 €